

INSTRUCTION MANUAL

Electric Firebox + Fireplace Suites

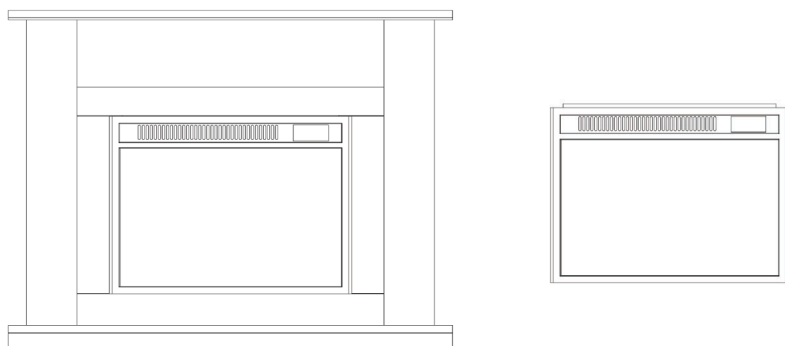

This product is only suitable for well insulated spaces or occasional use.

*This manual is used for a variety of products. Please make sure you follow the appropriate product guide lines. Illustrations are for reference only.

www.firedupcorporation.com/manual

Read ALL the instructions before use.

This manual is used for many different products. Please make sure you follow the appropriate product guide lines. Please refer to the front page for reference.

These instructions are for your safety. Please read through them thoroughly before use and retain for future reference. Failure to follow them could cause injury and/or property damage.

CONTENTS

SECTION 01

Cautions	03-06
Introduction	06

SECTION 02

Installing the fireplace	07-08
Remote control & touch panel	09

SECTION 03

Operation	10-12
Plug replacement	13
Technical parameters	14
Specification, Conformity & Environment	15
Guarantee & Contacts	16

CAUTIONS

DO'S

- Read ALL the instructions before using this product.

- Only use this product for its intended use as described in this manual.

- Always use the product in accordance with this guide. If in doubt obtain expert advice.

- Always check your mains supply is the same as that indicated on the product before connecting.

- Always make sure the electrical socket is accessible.

- Always disconnect the heater from the electrical supply before carrying out cleaning or maintenance. To disconnect the heater, switch controls to OFF then remove plug from the outlet.

- Ensure the floor space is flat and even.

DON'TS

- Never leave children unsupervised in a room where the fire is ON and unguarded.

- Never obstruct or cover the fan outlet or force items into fire openings.

- Never use the product anywhere where water is in use, i.e. bathrooms, kitchens, shower rooms, swimming pools etc.

- Never use aerosols or steam cleaners on or around the fire.
-
- Never route the supply cord under carpeting and never cover the cord with throw rugs, runners, etc. Arrange the cord away from traffic areas and where it will not be tripped over.
-
- Never place the heater close to curtains or combustible materials. Keep furniture, bedding, papers, clothes, curtains, etc. at least 1m away from the front of the heater and keep away from the sides and rear. Do not place the heater near a bed, where objects such as pillows or blankets could fall off the bed and be ignited by the heater.
-
- Never use the product to dry clothes etc.
-
- Never sit or stand on the product.
-
- Never lean or put weight on the product.
-
- Do not use outdoors.
-
- Do not sit the product on deep pile carpets or rugs.
-
- Avoid the use of an extension cord which may overheat and cause risk of fire. If an extension cord is necessary, it must be rated above the maximum rated power of the appliance. Care must be taken to arrange the cord so that it cannot be pulled or be tripped over.
-
- Do not attempt to open or modify the product.

IMPORTANT!

- This appliance can be used by children aged from 8 years and above and persons with reduced physical, sensory or mental capabilities or lack of experience and knowledge if they have been given supervision or instruction concerning use of the appliance in a safe way and understand the hazards involved.
- Children shall not play with the appliance.
- Cleaning and user maintenance shall not be made by children without supervision.
- If the supply cord is damaged, it must be replaced by the manufacturer, its service agent or similarly qualified persons in order to avoid a hazard.



WARNING: In order to avoid overheating,
DO NOT COVER THE HEATER

- The heater must not be located immediately below a socket outlet.
- Children of less than 3 years should be kept away unless continuously supervised.
- Please note the LED bulb in the appliance is non replaceable - do not attempt to replace it.
- Children aged from 3 years and less than 8 years shall only switch on/off the appliance provided that it has been placed or installed in its intended normal operating position and they have been given supervision or instruction concerning use of the appliance in a safe way and understand the hazards involved. Children aged from 3 years and less than 8 years shall not plug in, regulate and clean the appliance or perform user maintenance.

- **CAUTION** — Some parts of this product can become very hot and cause burns. Particular attention has to be given where children and vulnerable people are present.
- This heater is hot when in use. To avoid burns, do not touch hot surfaces such as surfaces around the grille in front of the heater. Never let bare skin touch hot surfaces.
- Do not use this heater in the immediate surroundings of a bath, a shower or a swimming pool.
- Do not use this heater if it has been dropped;
- Do not use if there are visible signs of damage to the heater;
- Use this heater on a horizontal and stable surface.
- **WARNING:** Do not use this heater in small rooms when they are occupied by persons not capable of leaving the room on their own, unless constant supervision is provided.
- **WARNING:** To reduce the risk of fire, keep textiles, curtains, or any other flammable material a minimum distance of 1 m from the air outlet.

Note: When the heater is turned on for the first time or when it has not been used for some time, it may release a slight, harmless odour. This odour is a normal occurrence caused by the initial heating of the internal heating elements and will disappear with use.

INTRODUCTION

Thank you for choosing this product. It is designed to meet the most stringent quality, performance, and safety requirements. This guide aims to improve your understanding and appreciation of your new product by providing simple and informative instructions.

INSTALLATION FROM THE REAR (Frameless)

Only install the fire from the rear on fireplaces that can be removed from the wall easily. This is so the fire can be serviced if required. The following procedure and dimensions are important.

Be aware that some fires may be pre-fitted to a surround.

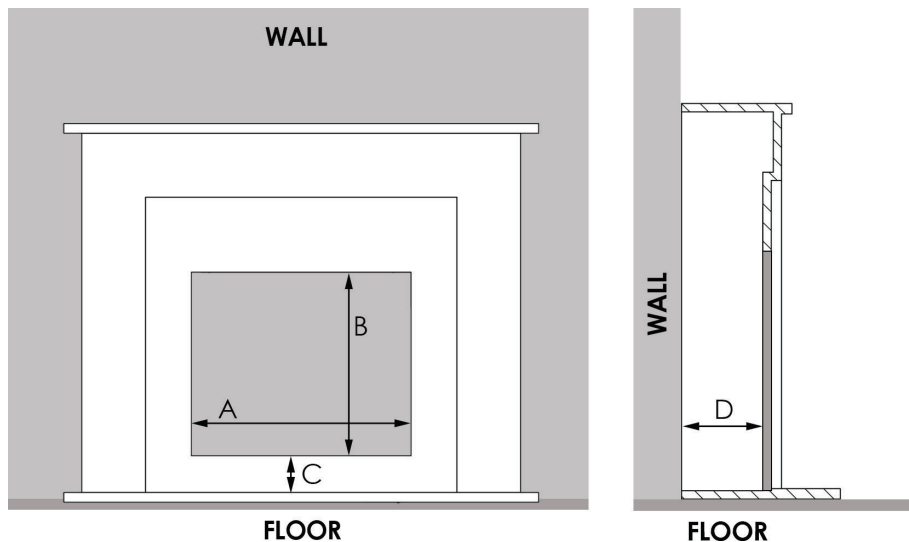

A (Opening width of back panel): 565mm

B (Opening height of back panel): 445mm

C (Distance between the hearth top & fuelbed): 0mm

D (Distance between the rear of the back panel and the wall): 120mm

FIXING THE FIREPLACE TO A WALL

This **ONLY** applies to wood based fireplaces (i.e MDF). For Marble & stone fireplaces, please refer to the instructions supplied with them.

If you have purchased the fire box with a surround, the following fixing kit will be supplied:

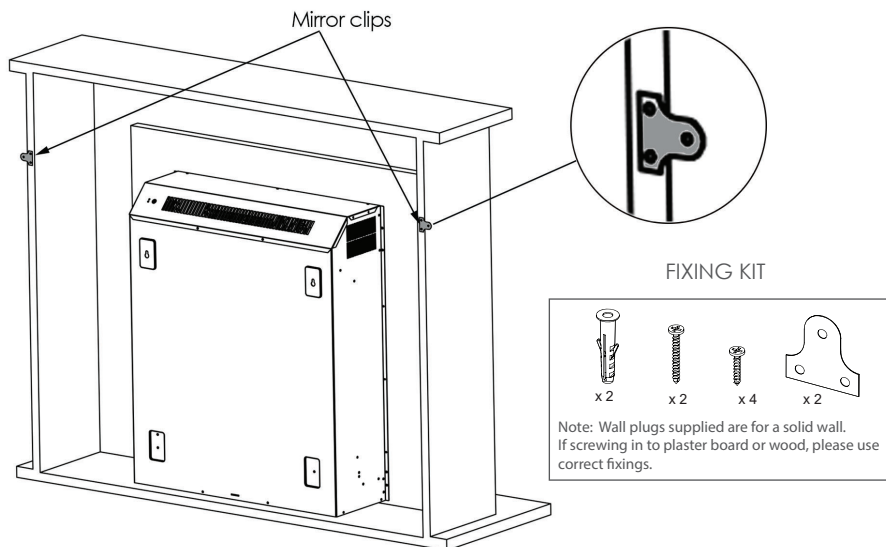

1. Fix the mirror clip to the back of the fireplace as shown using the 4 x small screws supplied. (It is recommended to drill a 2mm pilot hole to prevent the wood splitting.)
2. Position the fireplace to the wall and mark through the 2 remaining holes.
3. Remove the fireplace then drill 6mm diameter holes approximately 35mm deep.
4. Insert the wall plugs.
5. Position the fireplace to the wall then screw through the plates in to the wall using the 2 x large screws provided.

Remote control

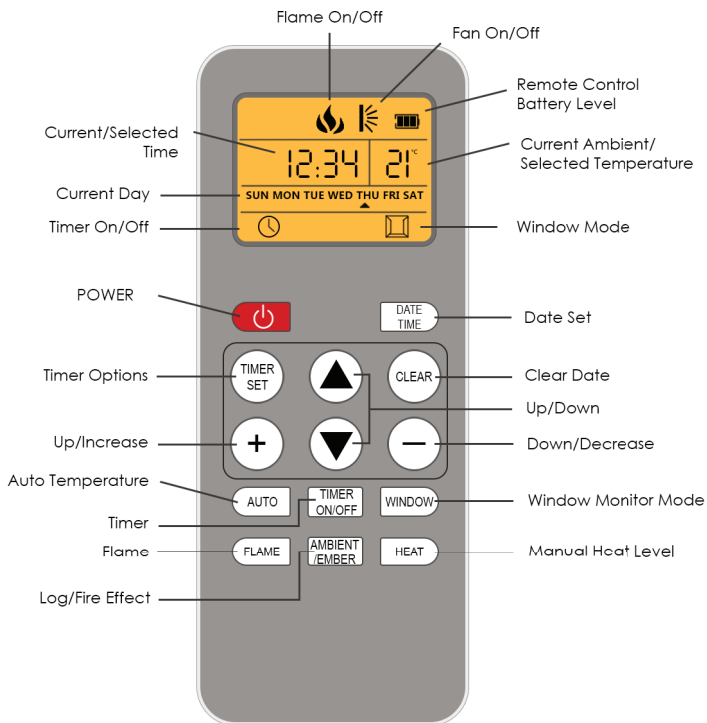

Timer period on - Displays when a timer period is active.

Touch panel

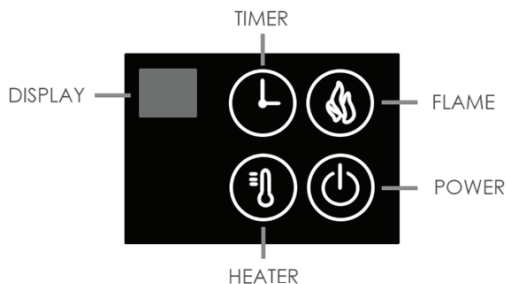

POWER - Turns the product ON/OFF

TIMER - Cycles through timer durations (1h, 2h, 3h, 4h, 5h, 6h, 7h, 8h, 9h)

FLAME - Controls lighting effect output (see lighting instructions for modes)

HEAT - Controls the heater (toggling the heater off will be delayed 60 seconds from being pressed)

- : Off
- 1 : Low heat (1000W)
- 2 : High heat (2000W)

A soft touch or tap must be used to operate the touch panel.

The touch panel can be used in place of the remote control for some functions, but remote control settings will be prioritised.

OPERATION - Remote control

Insert 2 x AAA batteries to the back of the remote control. Turn the power switch on.

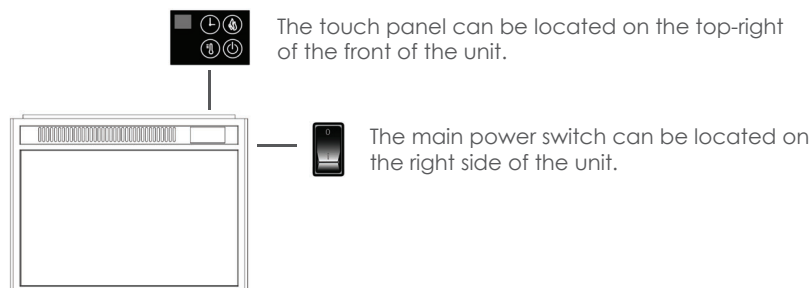

Power switch diagram



Note that the fire must be on when using the settings below.

Turn on heat

The heat function can be manually controlled using the "HEAT" button. There are three available manual heat functions:

-  Flame effect only
-  Flame effect & low heat setting (1000W)
-  Flame effect & high heat setting (2000W)

Note that the thermostat and timer controls cannot be programmed without the remote control.

Set thermostat (18°C - 35°C)

Press the "AUTO" button to activate the temperature-controlled mode.

Use the 'plus' (+) and 'minus' (-) buttons to increase or decrease the desired temperature, between 18°C and 35°C.

The unit will then automatically control the heating element to maintain the set temperature.

Set hourly timer

Press and hold the **"TIMER ON/OFF"** button to enable a 1 hour timer.

Press the button again to increase the timer an additional hour, up to a maximum possible 9 hour timer. After 3 seconds without input, the selected timer will be activated automatically.

Hourly timing mode can be disabled by pressing the **"TIME ON/OFF"** button after a 9 hour timer is selected, or by pressing and holding the **"TIME ON/OFF"** button for 5 seconds.

Set weekly timer

Setting current day and time

To use the weekly timer function, the current day and time must be set.

To set the current day and time, press the **"DATE TIME"** button.

The day of the week will then flash on the remote control. Use the ▲ and ▼ buttons to cycle through and select the day of the week. Press the **"DATE TIME"** button again to confirm the selected day.

This process will repeat for the hour, and then for the minute. For the hour and minute selection, use the 'plus' (+) and 'minus' (-) buttons.

Setting heat timer

Press the **"TIMER SET"** button. The timer cycle number will flash. Use the 'plus' (+) and 'minus' (-) buttons to cycle through the different timer cycles from 1 to 10, and press the **"TIMER SET"** button again to confirm the selection.

A triangle will then appear under the selected day. Use the ▲ and ▼ buttons to select the appropriate day(s). Use the 'plus' (+) button to confirm the selected day. Use the **"CLEAR"** button to cancel the set timer.

Repeat this process to add other days to the chosen timer cycle, or press the 'minus' (-) button to delete the set day and press the **"TIMER SET"** button to confirm.

Setting timer on/off time

The **"ON"** symbol will illuminate on the LCD display to indicate that the TIMER ON needs to be set.

Use the 'plus' (+) and 'minus' (-) buttons to set the hour for TIMER ON. Press the **"TIMER SET"** button to confirm. Repeat for the minute setting.

The **"OFF"** symbol will then illuminate on the LCD display to indicate that the TIMER OFF needs to be set. The same process can be repeated for the TIMER OFF setting.

Setting desired temperature

Once the **TIMER ON** and **TIMER OFF** times have been set, the set temperature will flash.

Use the 'plus' (+) and 'minus' (-) buttons to set the desired temperature, between 18°C and 35°C. Press the "**TIMER SET**" button to confirm.

Repeat this process to set more timer cycles as required.

Activating timer mode

To activate the timer, press the "**HEAT**" button and then press the "**TIMER ON/OFF**" button.

Set lighting effect*

*available on select models only

To adjust the lighting colour, ensure the unit is in '**0 Mode**.'

To toggle between '**P Mode**' and '**0 Mode**,' press and hold the '**EMBER/AMBIENT**' button.

Pressing the '**EMBER/AMBIENT**' button again cycles through 9 available modes.

00 - Off

01 - Green

02 - Blue

03 - Red

04 - Light Blue

05 - Yellow

06 - Purple

07 - White

08 - Colour Cycle Mode

Set flame effect

To adjust the flame effect brightness, ensure the unit is in '**P Mode**.'

To toggle between '**P Mode**' and '**0 Mode**,' press and hold the '**EMBER/AMBIENT**' button.

Pressing the '**EMBER/AMBIENT**' button again cycles through 9 available modes, where '**00**' disables the flame effect and subsequent modes ('**01**,' '**02**...') increase the brightness gradually up to a maximum setting of '**08**.'

Window monitor mode

Window monitor mode alerts the user, using an indicator on the '**HEAT**' button of the touch panel, if the ambient temperature is lowered due to the opening of doors or windows.

If there is no response from the user, the system will automatically stop heating.

To enable window monitor mode, press the "**WINDOW**" button. A window symbol will appear on the remote control.

TECHNICAL PARAMETERS

Information requirements for electric local space heaters

Item	Symbol	Value	Unit	Item	Unit
Heat output				Type of heat input, for electric storage local space heaters only (select one)	
Nominal heat output	P_{nom}	2	kW	manual heat charge control, with integrated thermostat	[yes/no]
Minimum heat output (indicative)	P_{min}	1	kW	manual heat charge control with room and/or outdoor temperature feedback	[yes/no]
Maximum continuous heat output	$P_{max,c}$	2	kW	electronic heat charge control with room and/or outdoor temperature feedback	[yes/no]
Auxiliary electricity consumption				fan assisted heat output	
					[yes/no]
At nominal heat output	eI_{max}	N/A	kW	Type of heat output/room temperature control (select one)	
At minimum heat output	eI_{min}	N/A	kW	single stage heat output and no room temperature control	[yes/no]
In standby mode	eI_{SB}	0	kW	Two or more manual stages, no room temperature control	[yes/no]
				with mechanic thermostat room temperature control	[yes/no]
				with electronic room temperature control	[yes/no]
				electronic room temperature control plus day timer	[yes/no]
				electronic room temperature control plus week timer	[yes/no]
				Other control options (multiple selections possible)	
				room temperature control, with presence detection	[yes/no]
				room temperature control, with open window detection	[yes/no]
				with distance control option	[yes/no]
				with adaptive start control	[yes/no]
				with working time limitation	[yes/no]
				with black bulb sensor	[yes/no]
Contact details	Name and address of the manufacturer or its authorised representative. See back page				

The seasonal space heating energy efficiency of all local space heaters except commercial local space heaters η_S (%): 38

SPECIFICATION

Model Number	-	LJIF-2301E
Supply Voltage	-	220-240V~50Hz
Rated Power	-	2000W
Class	-	1

CONFORMITY WITH DIRECTIVES

Conforms with relevant European Directives

ENVIRONMENTAL PROTECTION

(WEEE) Waste Electrical and Electronic Equipment

- Waste electrical products should not be disposed of with household waste. Please recycle where facilities exist. Check with your Local Authority or retailer for recycling advice.
- This appliance complies with the RoHS directive which restricts the use of certain hazardous substances in electrical and electronic equipment. This directive bans the placing on the EU market of new electrical and electronic equipment containing more than agreed levels of lead, cadmium, mercury, hexavalent chromium, polybrominated biphenyl (PBB) and diphenyl ether (PBDE) flame retardants.



AFFIX RECEIPT OR PROOF
OF PURCHASE HERE

GUARANTEE

For your convenience, you are not required to complete a form and return it to us in order to validate your guarantee. However, please ensure that you retain your receipt which will act as both proof of purchase and a guarantee validation document. **We recommend that you attach your receipt to this documentation.**

Your product carries a 12 month guarantee from the date of original purchase (or as otherwise provided in writing at point of purchase). If your product fails to operate to its specification, due to faulty workmanship or materials during the guarantee period, we will either repair or replace the product. We will use our discretion to determine whether to offer a repair or provide a replacement. The product will not be covered by the guarantee if it has been misused, transformed, modified or altered in any way.

If your product fails within the guarantee period please ensure that you have all necessary documentation available including proof of purchase (receipt or invoice with serial number, location and date of purchase) in addition to all original undamaged packaging and leaflets etc. It is strongly recommended that you inspect your product carefully before it is used or installed. For full details of your product you should refer to the instruction manual which accompanies the product. You are strongly advised to read this manual carefully in its entirety and to retain it for future reference.

This product guarantee does not affect your statutory rights.

CUSTOMER HELPLINE

 +44 (0) 3300 882 069

 customer.support@firedupcorporation.com



www.firedupcorporation.com

Fired Up Corporation Ltd
Fired Up Buildings
HD1 3LF, UK

Fired Up Corporation
(Ireland) Ltd
71, D02 P593, Dublin